

ALN-9745 “SLIMLINE” INLAY (HIGGS™ 4)

The Alien Technology® ALN-9745 “SlimLine” RFID inlay is a specialized thin-form factor high-performance tag. The ALN-9745 brings all the Higgs™ 4 advantages to a tag that can fit in extremely narrow confined spaces.



Applications

- Book spines
- Doors
- Cigarette boxes
- Small package labels
- Narrow form factor assets
- Shipping labels

FEATURE	DESCRIPTION	BENEFIT
Ultra slim form factor with performance similar to the Squiggle tag	Approaches the well regarded Squiggle/Squiglette performance tag in an ultra narrow form-factor	Smaller form factor, still robust, proven, and reliable
Next generation Higgs™ 4 features and performance	A mass-market optimized tag with class leading read and write performance. Supports pre-encoded MCS serialization and Aliens <i>BlastWrite</i> ™	Rapid programming of serialized tags and excellent read/write performance

Features:

- › Designed to meet EPCglobal Gen2 (V 1.2.0) and ISO/IEC 18000-6C
- › Worldwide operation in the RFID UHF bands (840-960 MHz)
- › 448-Bits of NVRAM Memory
 - 128-EPC Bits
 - 128 User Bits
 - 64 Bit Unique TID
 - 32 Bit Access and 32 bit Kill Passwords
- › Pre-Programmed with a unique, unalterable 64-bit serial number
- › User Memory can be Block Perma-Locked as well as read password protected in 32 Bit Blocks
- › Class leading read and write performance
- › Pre-encoded Multivendor Chip Serialization (MCS)
- › *BlastWrite*™ and *QuickWrite*™ mass-encoding
- › Dynamic Authentication™ - anti-cloning/anti-counterfeit technology
- › Exceptional operating range, up to 11m with appropriate antenna.
- › Available in high-yield, high capacity dry/wet inlay rolls

Product Overview:

Powered by Alien®’s break-through **Higgs™ 4 UHF RFID IC** and **innovative “SlimLine” antenna design**, the ALN-9745 delivers industry leading EPC Gen 2 performance and reliability in an ultra-narrow form-factor, making it ideal for mounting on narrow objects and boxes as well usage in narrow label applications.

With its Higgs-4 core, the “SlimLine” delivers next generation read and write performance, yet is completely **optimized for the highest volume enterprise, retail, and apparel applications.**

An optimized memory footprint includes a 32-bit TID, a **64-bit Unique TID for authentication** and **next generation serialization** applications, a 128-bit EPC memory bank, 128-bits of user memory for distributed data applications, and **password protected read and write** support capabilities to prevent unauthorized viewing and modification of the tag’s data.

ALN-9745 inlays are World Tag compliant, enabling consistent operation across the diverse frequencies of the Americas, Europe, Middle East, Asia, and Africa.



ALN 9745 SlimLine Inlay

ALN-9745 Inlay Orientation

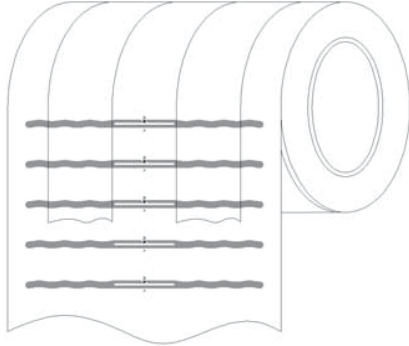

ALN-9745-R
(Dry Unslit Roll)

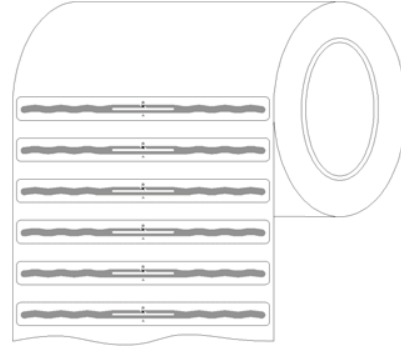

ALN-9745-WRW
(White Wet Inlay)

Standard Alien Inlay rolls unwind with metal antenna side facing outward, with respect to the core.

ALN-9745 Inlay/Tag Specification

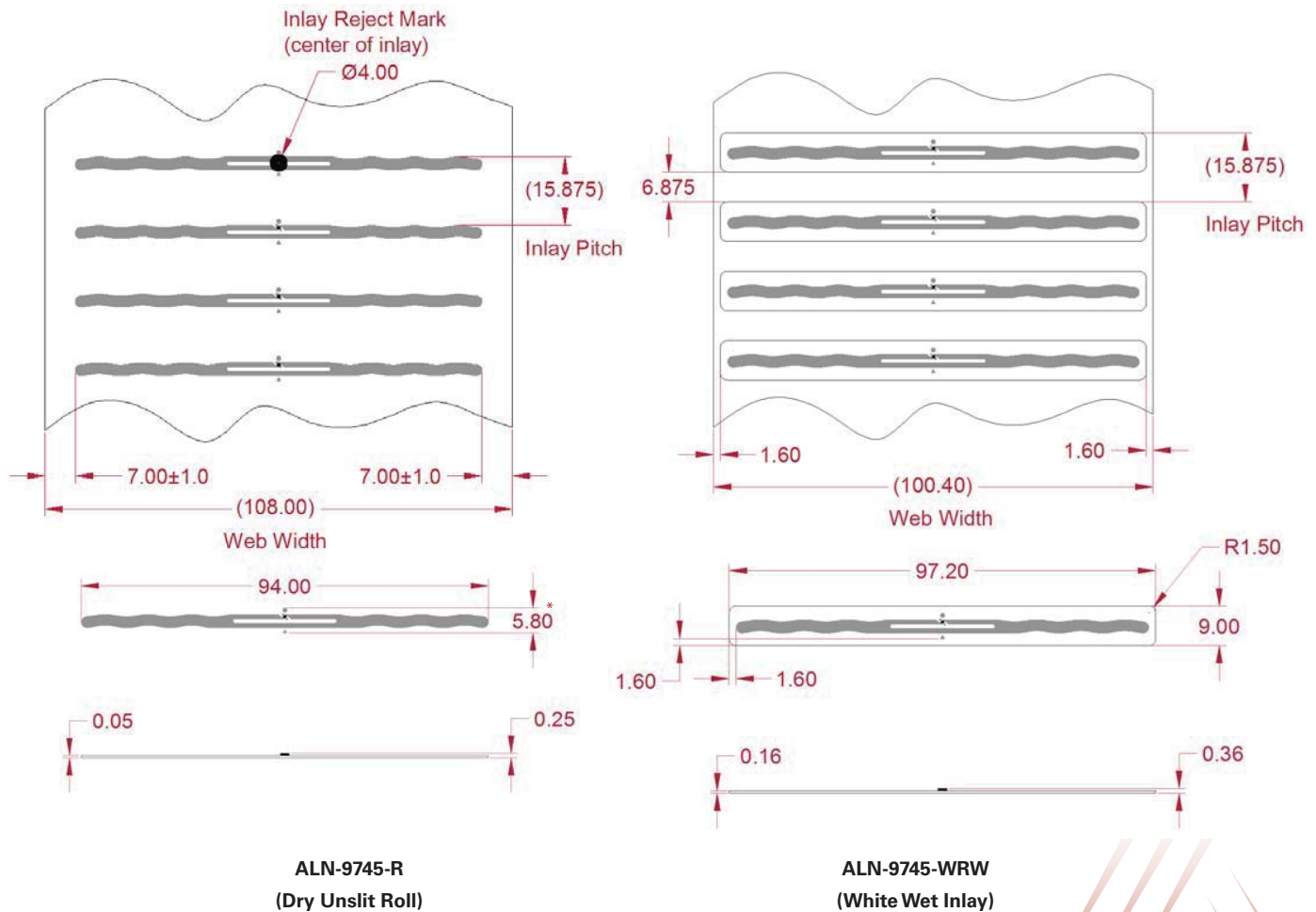

* NOTE: 5.80mm includes the two inlay targets that are not part of the functional antenna. 3.05mm is the functional antenna height (length).



ALN 9745 SlimLine Inlay

ALN-9745 Inlay Stackup

DRY INLAY THICKNESS, $\pm 10\%$	
OVER ANTENNA	0.05 mm
OVER CHIP	0.25 mm

WHITE WET INLAY THICKNESS, $\pm 10\%$	
OVER ANTENNA	0.16 mm
OVER CHIP	0.36 mm

INLAY

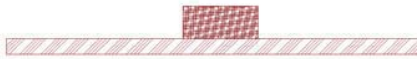

ALN-9745-R
(Dry Unslit Inlay)

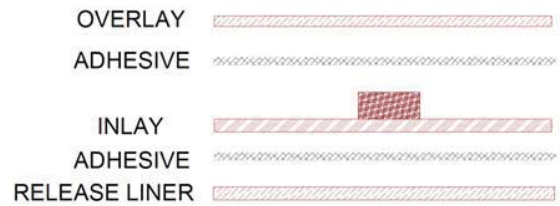

ALN-9745-WRW
(White Wet Inlay)

ALN-9745 Inlay Angular Sensitivity

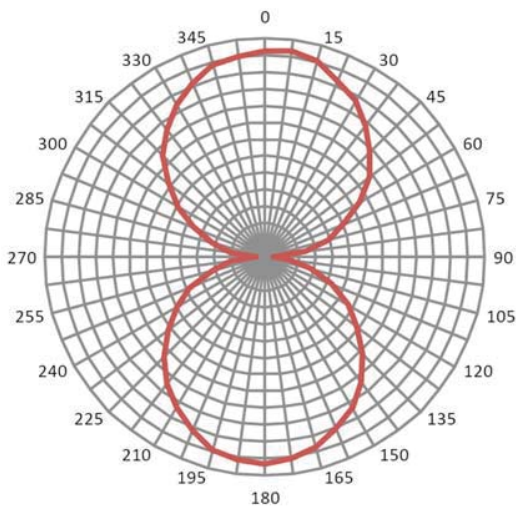

Angular Sensitivity
(Relative Read Range vs. Orientation)

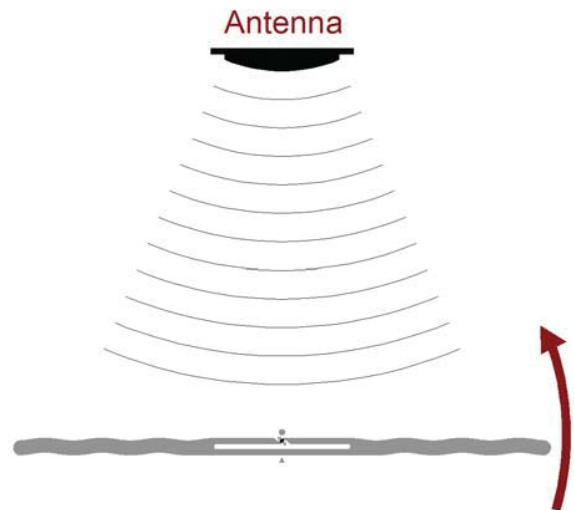

Angular Sensitivity
Inlay is rotated in the x, y, plane about the z axis
(tag shown at 0° with respect to face of antenna)

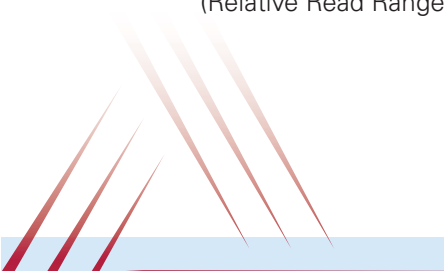



ALN 9745 SlimLine Inlay

ALN-9745 Specifications

Dry Inlay

Antenna Width	3.701" [94.0mm]
Antenna Length	0.228" [5.8mm]*
Web Width	4.252" [108.0mm]
Web Pitch	0.625" [15.875mm]
Core Width	4.252" [108mm]
Core ID	6" [152.4mm]**
Core Material	Fiberboard
Interleaf Material	Paper
Inlays per Roll	20,000 Nominal
Maximum Roll OD	< 12" [304.8mm]
Roll Labeling Data	Roll #, Quantity

* NOTE: 5.80mm includes the two inlay targets that are not part of the functional antenna. 3.05mm is the functional antenna height (length).

Wet Inlay

Inlay Width	3.827" [97.2mm]
Inlay Length	0.354" [9mm]
Web Width	3.95" [100.4mm]
Web Pitch	0.625" [15.875mm]
Core Width	3.953" [100.4mm]
Core ID	6" [152.4mm]**
Core Material	Fiberboard
Inlays per Roll	20,000 Nominal
Maximum Roll OD	< 16" [406.4mm]
Roll Labeling Data	Roll #, Quantity
White	TT Printable White Film Only
Overlay Adhesive	General Purpose Permanent
Inlay Adhesive	General Purpose Permanent
Adhesive Application Temperature	> +25°F [-4°C]
Adhesive Service Temperature	-40°F to +200°F [-40°C to +93.3°C]
Release Liner	40# SCK

** Shipped with 6" to 3" plastic core adapter

Copyright © 2013 Alien Technology Corporation. All rights reserved.
 Alien, Alien Technology, the Alien Technology logo, FSA, Higgs, Dynamic Authentication, BlastWrite, QuickWrite, Squiggle, and the Squiggle logo are trademarks or registered trademarks of Alien Technology Corporation in the U.S. and other countries.
 HANDLING PRECAUTIONS Observe standard handling practices to minimize ESD.
 DISCLAIMER Application recommendations are guidelines only - actual results may vary and should be confirmed. This is a general purpose product not designed or intended for any specific application.

This product is covered by one or more of the following U.S. patents: 7967204, 7931063, 7868766, 7737825, 7716208, 7716160, 7688206, 7659822, 7619531, 7615479, 7598867, 7580378, 7576656, 7562083, 7561221, 7559486, 7559131, 7554451, 7551141, 7542301, 7542008, 7531218, 7522055, 7500610, 7489248, 7453705, 7425467, 7417306, 7411503, 7385284, 7377445, 7364084, 7353598, 7342490, 7324061, 7321359, 7301458, 7295114, 7288432, 7265675, 7262086, 7260882, 7253735, 7244326, 7218527, 7214569, 7199527, 7193504, 7173528, 7172910, 7172789, 7141176, 7113250, 7101502, 7080444, 7070851, 7068224, 7046328, 6998644, 6988667, 6985361, 6980184, 6970219, 6952157, 6942155, 6933848, 6927085, 6816380, 6780696, 6731353, 6693384, 6683663, 6665044, 6657289, 6623579, 6606247, 6606079, 6590346, 6586338, 6566744, 6555408, 6527964, 6479395, 6468638, 6420266, 6316278, 6291896, 6281038. Other patents pending.

27 June 2013

Environmental

Shelf Life	2 years at +77°F [+25°C] @ 40%RH
Recommended Storage	+77°F [+25°C] @ 40% RH
Storage Limits	-13°F to 122°F [-25°C to +50°C] 20% to 90% RH Non-condensing
Operating Limits	-40°F to +158°F [-40°C to +70°C] 20% to 90% RH Non-condensing
Bend Diameter	> 1.97" [50mm]
Pressure	< 5N/mm ²
Drop Resistance	Per ASTM D5276
Write Cycles	100,000 @ 25°C
RoHs	2002/95/EC, 2005/618/EC, 2011/65/EU Compliant
REACH	1907/2006/EC Compliant (SVHC and ECHA)
ESD Limit- HBM / CDM	5.0kV / 1.5kV

RFID

Protocols Supported	ISO/IEC 18000-6C EPCglobal Class 1 Gen 2
Integrated Circuit	Alien Higgs-4
EPCglobal Certificate	95011012600001084
Operating Frequency	840-960 MHz
EPC Size	128 Bits
User Memory	128 Bits
TID	32 Bits
Unique TID	64 Bits
Access Password	32 Bits
Kill Password	32 Bits



Alien Technology
 18220 Butterfield Blvd.
 Morgan Hill, CA 95037
 866-RFID NOW
 www.alientechnology.com